



Congratulations, you have chosen a truly spectacular machine. Read the user's manual carefully and follow the instructions given for "preparing" your Oscar professional. You will realize how easy it is to have superb coffee and creamy cappuccinos. In time you will also come to realize how little maintenance is needed. One thing is certain, Oscar will be the "star" of your bar.

Nuova Simonelli s.r.l.



The international mark of approval certifies that all our machines have undergone severe tests and inspections. (International certification attests to the thorough testing and calibration of these machines).

ENGLISH

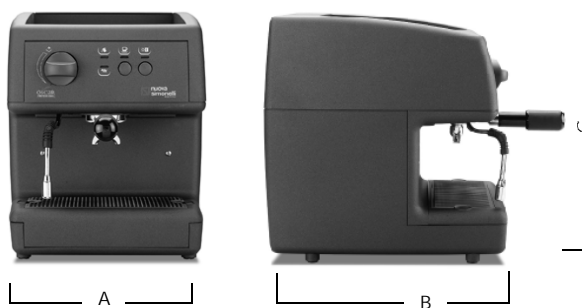

MODELS	N. OF UNITS	NET WEIGHT	GROSS WEIGHT	HEATING CAPACITY	VOLTS/Hz	DIMENSION mm		
						A	B	C
OSCAR SPECIAL MODELS: DIRECT CONNECTION	1	14 Kg. 31Lb	17 Kg. 37Lb	1200 W	115 - 230V 50 - 60 Hz	300 12"	400 15,8"	400 15,8"

---

# CONTENTS

<b>DELIVERY LETTER</b>	pag. 11
<b>INTRODUCTION AND TECHNICAL FEATURES</b>	pag. 11
<b>GENERAL DELIVERY NOTES</b>	pag. 13
<b>SAFETY INDICATIONS</b>	pag. 13
<b>SHIPPING AND HANDLING</b>	pag. 15
<b>CONTROL PANEL</b>	pag. 16
<b>INSTALLATION</b>	pag. 17
■ preliminary operations	pag. 17
■ setting up the machine	pag. 17
<b>START UP</b>	
■ preparing a single cup of coffee	pag. 18
■ preparation of two cups of coffee	pag. 18
■ how to produce steam	pag. 18
<b>SHUT DOWN</b>	pag. 19
<b>CLEANING</b>	pag. 19
<b>MAINTENANCE</b>	pag. 19
<b>TROUBLESHOOTING</b>	pag. 20
<b>DIAGRAM</b>	pag. 53

---

## GENERAL DELIVERY NOTES

The machine and all parts are generally delivered in palletized cartons. Upon receipt check that:

- 1) All packaging is intact;
- 2) The contents are the:
  - a) Machine
  - b) Box of accessories:
 

b1) Filter holder	b2) Filter spring
b3) Two-cup filter	b4) Single-cup filter
b5) Coffee press	b6) Coffee measur e
- 3) The machine and accessories are not damaged in any way.

In case of damage or missing pieces, immediately contact the manufacturer or its sales agent in your area or its insurance company.

## SAFETY INDICATIONS



The present manual is an integral and essential part of the product and is to be delivered to the user. Carefully read all warnings in the manual as they provide important information required to install, use and maintain the unit safely. Keep this manual in a safe place for further consultation.



After having removed the packaging, make certain that the unit is not damaged in any way. If you have any doubts, do not use the unit and contact a professionally qualified person. Always keep all packaging (plastic bags, polystyrene foam, nails, etc.) out of the reach of children as they are a potential source of danger and never loiter the environment with such materials.



**DANGER OF POLLUTION**

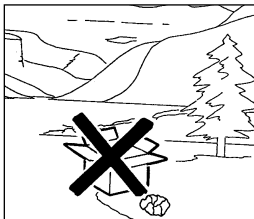

Before turning on the unit make certain that the rating indicated on the label matches the available power supply. The label is located under the machine work base at the upper right. Installation must be performed following the standards in force in the country where it is being installed and following the manufacturer's instructions. Only skilled personnel can install this unit.

The manufacturer cannot be held responsible for any damages incurred if the system is not grounded. For electrical safety, this machine requires a ground system. Contact a technically certified electrician who must check that the line electrical capacity is adequate for the maximum capacity indicated on the unit label.

The electrician must also check that the line cables have adequate section to handle the power absorbed by the unit. Never use adapters, multiple jacks or extension cords. When such items prove absolutely necessary, call in a qualified electrician.

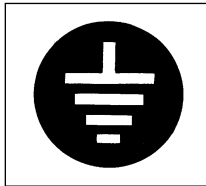

The machine must be installed in compliance with the local health standards in force for plumbing systems. Therefore, contact an authorized plumber.



This unit must only be used for the purposes described in the present manual. The manufacturer cannot be held responsible for any damages caused by improper, mistaken and unreasonable use.



**WARNING**

Before using the machine, read this manual in its entirety or, at the very least, read the safety and set up instructions.



There are some basic rules for the use of any electrical appliance. In particular:

- never touch the unit with wet hands or feet;



**CAUTION**

**DANGER OF ELECTRIC SHOCKS**

All cleaning, washing and other operations performed on the inside of the machine must be performed when the machine is in a state of "ZERO ENERGY"; that is unplugged from the mains.

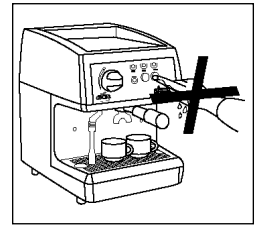

- never use the unit with bare feet;
- never use extension cords in areas equipped with baths or showers;
- never pull on the power supply cord to unplug the unit;
- never leave the unit exposed to atmospheric agents (rain, direct sunlight, etc.);
- never let children, unauthorized personnel or anyone who has not read this manual operate the unit.

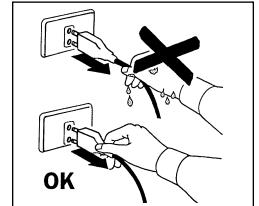

**OK**



Before performing any sort of maintenance, the authorized technician must turn off the unit and unplug it from the mains.

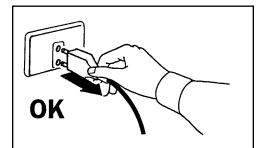

**OK**



Before cleaning the unit set it in a state of "0" energy: that is, "MACHINE SWITCHED OFF AND UNPLUGGED". Follow the instructions given in this manual carefully.



In case of breakdown or poor function, turn off the unit. Never tamper with the unit. Contact only professionally qualified personnel. Only the manufacturer or an authorized service center can make repairs and only using original spare parts.

Non compliance with the above can compromise machine safety.

**9** Upon installation, the qualified electrician must arrange for an omnipolar switch, as called for by the safety regulations in force; when open, the contacts must be 3 mm or more apart.

**10** To prevent dangerous overheating, it is advisable to fully extend the power supply cord.

**11** Never block the intake and/or heat dissipation grills, in particular those for the cup warmer.

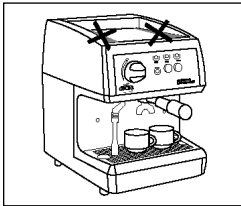

**12** The user must never replace the unit's power supply cord. If this cord is damaged, turn off the unit and have it replaced by a professionally qualified technician.

**13** Should you decide to stop using this type of unit, we suggest you render it inoperable by unplugging it and cutting the power supply cord.

**!** Caution: DANGER OF POLLUTION

Never dispose of the machine in the environment: to dispose of the machine, contact an authorized center or contact the manufacturer for pertinent indications.

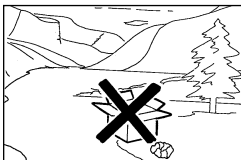

**14** To facilitate aeration of the unit, position the aeration portion of the machine 15 cm from walls or other machinery.

**15** Once you have started washing the machine, complete the job or residues of detergent could be left inside the dispensing assembly.

**!** Caution: DANGER OF INTOXICATION

**16** Be extremely careful when using the steam nozzle. Never place your hands under the nozzle and never touch it right after use.

**!** Caution: DANGER OF BURNS

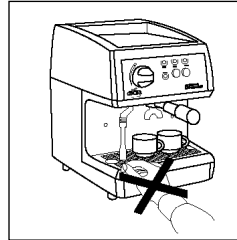

**17** Remember that to install, maintain, unload and regulate the unit, the qualified operator must always wear work gloves and safety shoes.

**18** When adding the coffee, the operator must never put his hands into the container.

# SHIPPING AND HANDLING

## Machine ID

When communicating with the manufacturer Nuova Simonelli, always cite the machine ID number.

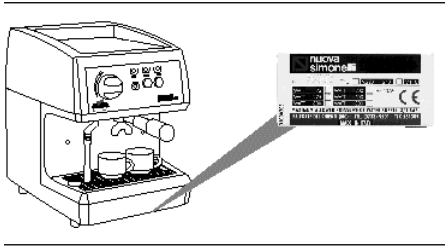

The machine is transported on pallets containing several machines inside cartons strapped to the pallet. Operators performing any shipping or handling operations must wear gloves, safety shoes and overalls with elasticized cuffs. Always move pallets using adequate equipment (i.e. fork lift trucks).

### CAUTION: DANGER OF IMPACT OR PINCHING

During handling, the operator must make certain that there are no persons, things or objects in the vicinity. Slowly lift the pallet approximately 30 cm off the ground and drive to the loading zone. After having made certain that there are no obstacles, things or persons in the way, proceed with loading. Once the destination has been reached, again using adequate lifting equipment (i.e. fork lift truck) and after having made certain that there is nothing and no one in the unloading area, set the pallet on the ground and move it to the storage area; always carry the load at a height of approximately 30 cm from the ground.

### CAUTION: DANGER OF IMPACT OR PINCHING

Before performing the following operations, make certain that the load is in sta-

ble and will not fall when the straps are cut.

Wearing gloves and safety shoes, the operator must cut the straps and store the product. During this operation, see the product technical features for the weight of the machine being stored and proceed as necessary.

### CAUTION: DANGER OF POLLUTION

Once the machine has been released from the pallet or container, do not pollute the environment with these items.

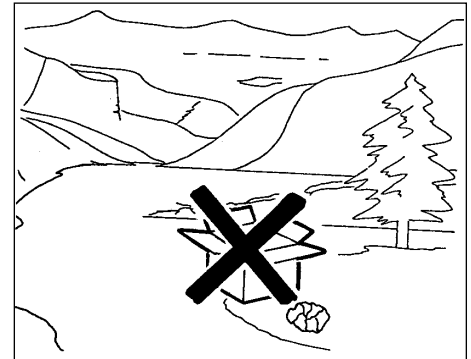

# DESCRIPTION OF CONTROL PANEL AND OPERATIONS

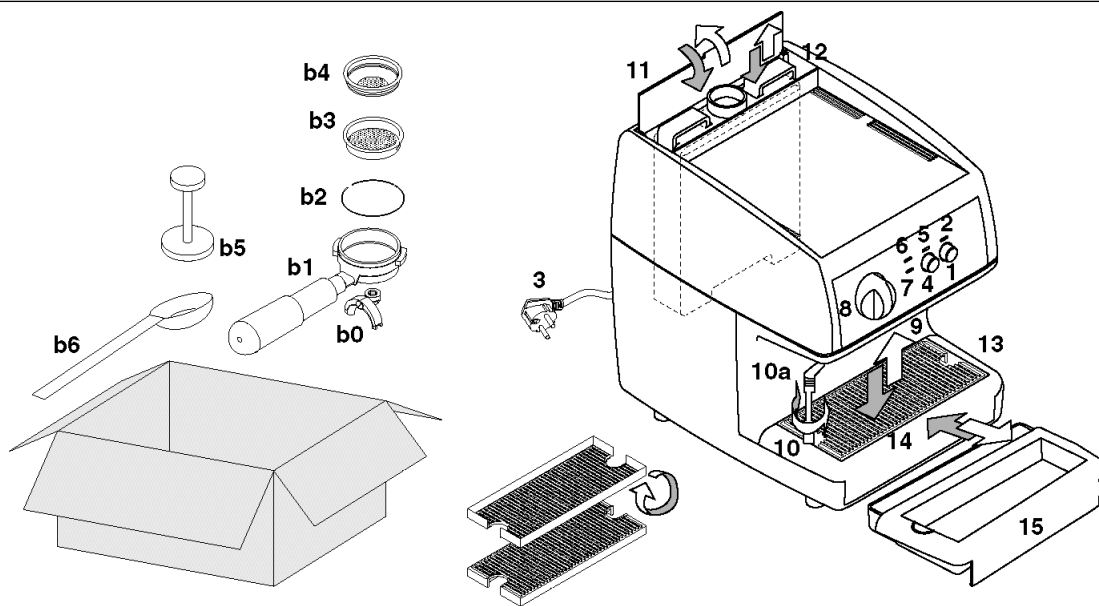

- |  |   |   |
|--|---|---|
| <p>1) Main switch.</p> <ul style="list-style-type: none"> <li>- When pressed this switch powers the machine (light 2 on) and starts boiler heating (light 7 on)</li> <li>- Pressing this switch again turns the machine off (light 2 off), and stops boiler heating (light 7 off)</li> </ul> <p>2) Unit ON light.</p> <ul style="list-style-type: none"> <li>- When this light is ON, the machine is powered and operative.</li> <li>- When this light is OFF the machine is off.</li> </ul> <p>3) Power supply plug.</p> <p>4) Coffee dispensing button.</p> <ul style="list-style-type: none"> <li>- Press this button and the unit starts dispensing coffee (and continues for as long as it remains pressed) (light 5 on)</li> <li>- Press the button again and the unit stops dispensing coffee (light 5 off).</li> </ul> | <p>5) Coffee dispensing light.</p> <ul style="list-style-type: none"> <li>- This light remains on while coffee is being dispensed</li> </ul> <p>6) Reservoir empty light.</p> <ul style="list-style-type: none"> <li>- When this light is on, the water reservoir (12) needs to be refilled.</li> </ul> <p>7) Heating element light.</p> <ul style="list-style-type: none"> <li>- ON: the heating element is functioning.</li> <li>- OFF: the boiler has reached operating temperature or the machine is off.</li> </ul> <p>8) Steam knob.</p> <ul style="list-style-type: none"> <li>- Turn the knob and adjust the jet of steam.</li> </ul> <p>9) Delivery assembly attachment. Filter holder housing (b1).</p> <p>10) Moveable steam nozzle with insulated outlet (10a). Delivers steam to heat liquids in containers.</p> | <p>11) Water reservoir hatch.</p> <p>12) Water reservoir</p> <p>The reservoir can hold 2.3 liters of water. Although the unit can operate with any type of water, the lower the water hardness the longer the unit will last.</p> <p>13) Cup warming grill.</p> <p>14) Cup warming shelf.</p> <p>15) Cup support grill.</p> <p>16) Water drain tank.</p> <p>b0) Coffee nozzle</p> <p>b1) Filter holder</p> <p>b2) Spring</p> <p>b3) Two-cup filter</p> <p>b4) Single-cup filter</p> <p>b5) Coffee press</p> <p>b6) Coffee measure</p> |
|--|---|---|

# INSTALLATION

Before installing the unit, carefully read the safety instructions at the beginning of this manual; in particular read how to set the unit in a STATE OF ZERO ENERGY and the PRELIMINARY OPERATIONS.

- 1) Once the machine has been withdrawn from the packaging, follow the instructions given in the "GENERAL DELIVERY NOTES".
- 2) Position the unit on a horizontal surface.

## Arrange the accessories as follows:

- 3) Insert the ring (b2) into the hollow in the filter holder.
- 4) Insert one of the two filters (b3 or b4).
- 5) Caution: danger of pollution

 **DO NOT DISPOSE OF PACKAGING MATERIALS IN THE ENVIRONMENT**

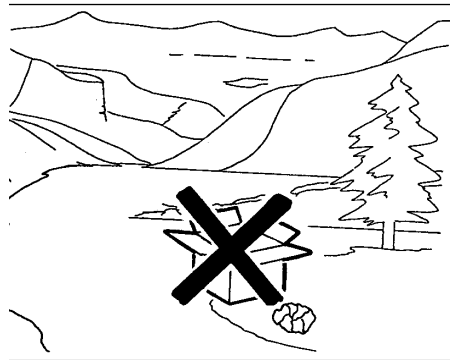

- 3) Open the hatch (11).
- 7) Withdraw the reservoir (12).
- 3) Particularly the first time, wash the reservoir with soap and water.
- 3) Fill the reservoir with water.

- 10) Make certain that the outside of the reservoir is dry.
- 11) Return the reservoir (12) to its housing.
- 12) Close the hatch (11).
- 13) Make certain that the water drain tank (16) has been inserted.
- 14) Two types of cup support grills (15) are possible:

a) tall cups

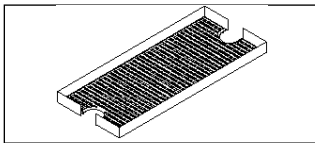

b) normal cups

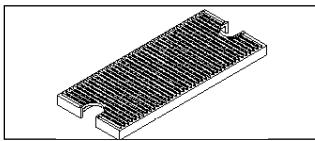

Make certain that the cup support grill (15) is positioned squarely and is level.

- 15) Make certain that the steam knob (8) is closed.
- 16) Make certain that the two buttons (1 and 4) protrude and are not pressed.

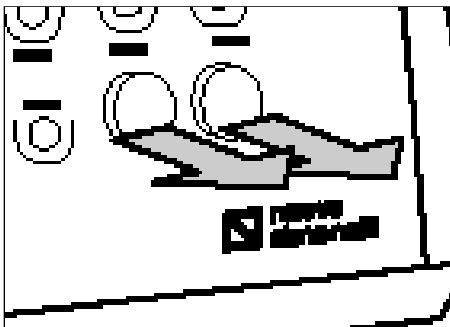

- 17) Make certain that the line voltage corresponds to the requirements indicated on the label.
- 18) Only if the steam valve (8) is closed, buttons (1 and 4) are not pressed and the line voltage matches the label requirements, plug the unit into the power supply outlet.
- 19) The preliminary operations have been completed and the machine is ready to be set up.

## SETTING UP THE MACHINE

Note: if the sequence indicated below does not take place, see the chapter entitled "TROUBLESHOOTING".

After having completed the preliminary operations:

- 1) Make certain that the steam valve (8) is closed.
- 2) Press the main switch (1) to turn on the unit; the machine automatically feeds water into the boiler (initial time: approximately 3 min), once the water has reached the set level, the unit starts heating and the heating light goes on.

Note: the machine has an electronic level valve so it automatically feeds in water to the boiler as needed to restore the level.

**N.B.:** the machine safety system shuts down the machine after the pump has been running steadily for approximately 2 minutes (this prevents the pump from overheating). In this case, turn off the

**machine by pressing the main switch and then turn it on again.**

While the unit is operating, the ON light (2) and the heating light (7) are both lit.

- 3) Wait until the heating light (7) goes off, indicating that the water has reached the desired temperature.
- 4) Note: if the water light (6) goes on, it means that the water reservoir (12) is empty or nearly empty.
- 5) Note: remember that to obtain a good drink it is best to use the cup warming shelf (14) to keep the cups warm.
- 3) At this point the machine has been set up and is ready to make coffee or produce steam.

## PREPARING A SINGLE CUP OF COFFEE

Note: if the sequence indicated below does not take place, see the chapter entitled "TROUBLESHOOTING".

- 1) After having set up the machine, check that the single-cup filter (b4) is set in the filter holder (b1).  
If necessary replace the filter, perhaps prying it out with a tool.

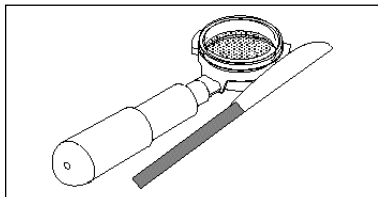

- 2) Fill the coffee measure (b6) flush.
- 3) Place the coffee into the single-cup filter (b4).
- 4) Using the press (b5), compact the coffee uniformly.
- 5) Clean the edge of the filter.

- 6) Rotating the filter holder (b4) insert it into the attachment (9) until it is tight.
- 7) Position the cup under the spout.
- 8) Press the coffee dispensing button (4), light 5 goes on and coffee starts filling the cup.
- 9) Once the desired level has been reached, press button 4 to stop the flow and light 5 goes off.
- 10) Note: if the unit is to be used frequently the coffee can be left in the filter until the next serving.  
If it is not used frequently, empty out the filter and clean it.
- 11) At this point you have finished preparing of a single cup of coffee.

## PREPARING TWO CUPS OF COFFEE

Note: if the sequence indicated below does not take place, see the chapter entitled "TROUBLESHOOTING".

- 1) After having set up the machine, check that the two-cup filter (b4) is set in the filter holder (b1).  
If necessary replace the filter, perhaps prying it out with a tool.

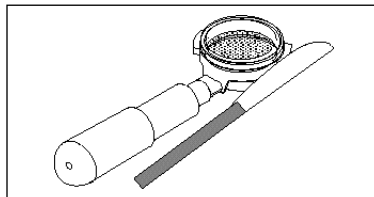

- 2) Fill the coffee measure (b6) flush.
- 3) Place the coffee into the two-cup filter (b3).
- 4) Fill the coffee measure (b6) a second time.
- 5) Place the second dose of coffee into

the two-cup filter (b3).

- 6) Using the press (b5), compact the coffee uniformly.
- 7) Clean the edge of the filter.
- 8) Rotating the filter holder, insert it into the attachment (9) until it is tight.
- 9) Position the cups under the spouts.
- 10) Press the coffee dispensing button (4), light 5 goes on and wait until coffee starts filling the cups.
- 11) Once the desired level has been reached, press button 4 to stop the flow and light 5 goes off.
- 12) Note: if the unit is to be used frequently the coffee can be left in the filter until the next serving.  
If it is not used frequently, empty out the filter and clean it.
- 13) At this point you have finished preparation of two cups of coffee.

## HOW TO PRODUCE STEAM

Note: if the sequence indicated below does not take place, see the chapter entitled "TROUBLESHOOTING".

- 1)  **CAUTION: DANGER OF BURNS**  
When maneuvering the steam nozzle (10) you must use the insulated potholder (10a).

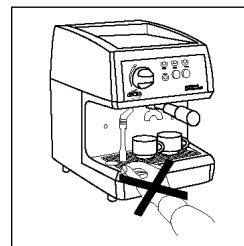

- 2) After having set up the machine, clean the steam nozzle with a cloth dipped in hot water.
- 3) Make certain that the spout of the nozzle is within the grill (15).
- 4) Gradually open the steam knob (8)



carefully and keep it open until any drops of hot water that may be inside the nozzle come out and...

- 5) When only steam comes out of the nozzle, move it with the insulating holder (10a) and insert it into the liquid you want to heat.
- 3) Use knob 8 to adjust the steam as needed.  
Keep the nozzle in the liquid while regulating the steam.
- 7) Once the liquid has been heated, close the steam knob (8) and remove the nozzle from the heated liquid.
- 3) Use a cloth dipped in hot water to clean any residues of the heated liquid from the steam nozzle spout (21).
- 3) You have finished heating the liquid.

## SHUTDOWN

To shut down the machine, press the main switch (1) and all the lights go off.  
Note: if the machine will be off for a long time, to ensure safety unplug it from the power supply.

## CLEANING

Except for cleaning of dispensing assembly 9 – shown in the table below – any other form of cleaning must be performed when the unit is in a condition of zero energy (off and unplugged from the power supply) and only after the hot parts have cooled to room temperature. See the table below:

N°	ITEM TO BE CLEANED	Part no.	FREQUENCY		
			immediately after use	daily	weekly
1	Steam nozzle	10	■	■	■
2	Filter and filter holder	b1,b3,b4	■	■	■
3	Outside of the machine	a		■	■
4	Grill	15		■	■
5	Liquid tank	16	■	■	■
6	Water reservoir	12			■
7	Dispensing spout	9		■	
8	Gasket on the dispenser assembly	9		■	■
9	Dispenser assembly	9			■

- 1) Cleaning the steam nozzle  
Use a cloth dipped in hot water and/or a neutral detergent.
- 2) Cleaning the filter and filter holder
  - If necessary use a tool to pry the filter (b3/b4) out of the filter holder (b1).
  - Rinse under a jet of water (tap) and dry.
  - If necessary, use a small brush to clean out the filter.
- 3) Cleaning the outside of the machine
  - Never use any sort of solvent to clean the outside of the machine; use only a cloth dipped in hot water and a neutral soap.
- 4) Cleaning the grill.
  - Brush the grill clean with hot water and soap.
- 5) Cleaning the liquid tank
  - Clean the liquid tank with hot water and soap, if necessary using a brush.

NOTE: the liquid tank can be washed in the dishwasher.

CAUTION: never use any sort of solvent.
- 6) Cleaning the water reservoir
  - Use soap and water and rinse thoroughly.

NOTE: if for any reason the water has left undesired scale, wash out with a swab.
- 7) Cleaning the dispensing spout
  - CAUTION: DANGER OF BURNS: this operation is performed with the unit on and for this reason requires utmost care.
  - Clean the holes in the dispensing spout using a brush with slightly stiff bristles.
  - Press the dispensing button (4) to unplug the holes.
- 8) Cleaning the gasket on the dispenser assembly
  - Use a small brush to clean away any scale or coffee residues from the gasket on the dispenser assembly
- 9) Cleaning the dispenser assembly
  - Use a small brush to clean away any scale or coffee residues from the dispenser assembly spout.

## MAINTENANCE

If the above-mentioned cleaning operations are performed, no other maintenance is required.  
Contact the dealer where you purchased the unit for any operations required.

## TROUBLESHOOTING

If your espresso coffee maker is not functioning properly, see if you can find the problem in the troubleshooting list below. Also reread the corresponding sections in the user's manual.

<b>Problem</b>	<b>Remedy</b>
<b>The machine does not prepare the espresso coffee.</b>	Check whether the reservoir empty light is on: no water in the reservoir, or reservoir not inserted correctly. The coffee has been ground too fine or has been pressed too hard. The spout is plugged. Scale must be removed from the machine.
<b>The coffee comes out of the sides of the filter holder.</b>	The filter holder was not inserted correctly. The filter holder was not tightened enough. Clean coffee grinds away from the gasket (see the section on cleaning).
<b>There is too little or no "cream"</b>	Check the amount of coffee: the measure must be filled level. The machine is not hot: is the heating element off? The coffee has not been ground fine enough. The coffee in the filter has not been pressed correctly The coffee is not fresh. The water is not fresh.
<b>The "cream" is too dark and/or the coffee has a burnt flavor</b>	The coffee has been ground too fine. The coffee has been pressed too hard. Too much coffee has been measured.
<b>The coffee is not hot enough</b>	The hot water passes through the filter too quickly. It takes 25-40 seconds to make 2 cups. The coffee in the filter has not been pressed correctly. The coffee has not been ground fine enough. The filter holder is cold. The filter holder should always left inserted in the machine while the unit is heating up and during use so it remains hot. The cups are cold. The cups must be placed on the heated shelf or preheated with hot water prior to use. The boiler safety thermostat has cut in: contact the nearest service center.
<b>The pump does not suck water from the tank</b>	Open the steam tap (8) and push repeatedly the coffee delivery key (4).

## SCHEMA ELETTRICO "OSCAR"

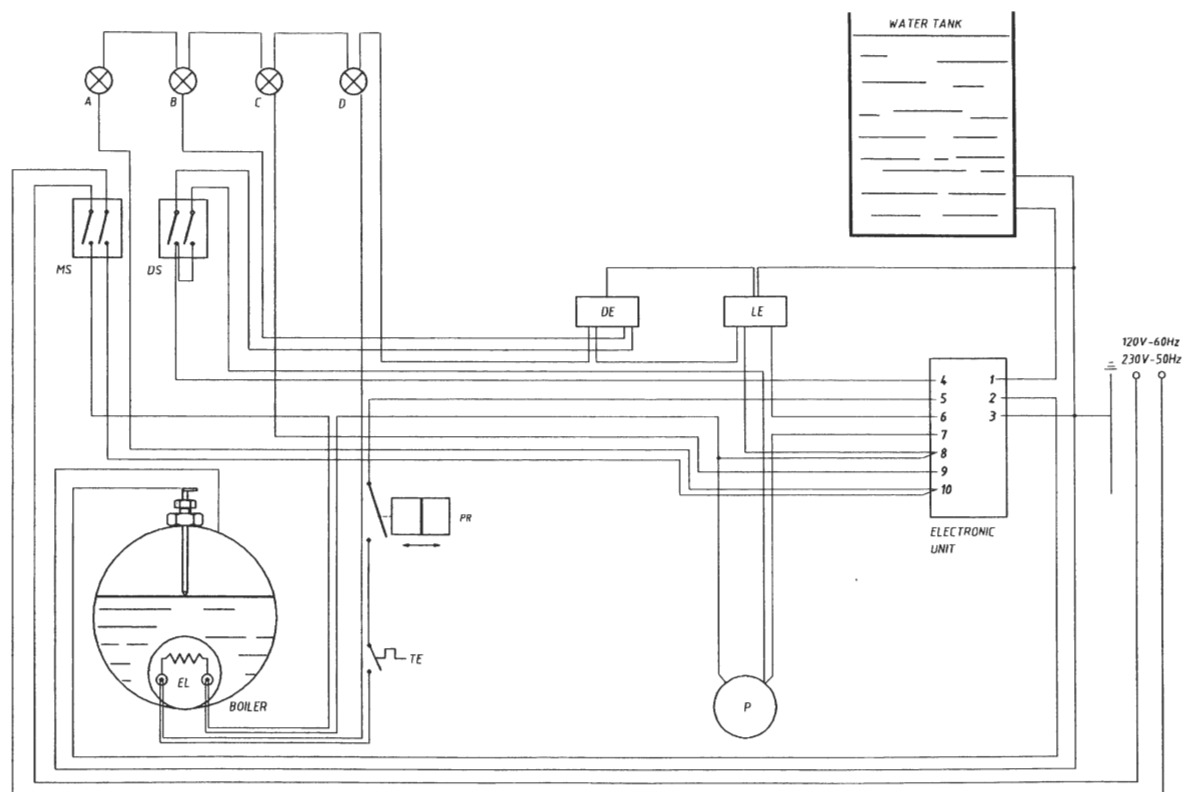

### Legenda

<p>A spia accensione on-off lamp témoin lumineux d'actionnement Einschaltkontrolleuchte luz testigo de encendido</p>	<p>C spia mancanza acqua serbatoio no-water lamp témoin lumineux manque d'eau dans le réservoir Kontrolleuchte bei Wassermangel luz testigo falta de agua depósito</p>	<p>DS interruttore erogazione caffè coffee delivery switch interrupteur distribution café Kaffeeausgabeschalter interruptor erogación café</p>	<p>PR pressostato pressure switch pressostat Druckwächter presóstat</p>
<p>B spia erogazione caffè coffee delivery lamp témoin lumineux distribution café Kaffeeausgabe-Kontrolleuchte luz testigo erogación café</p>	<p>D spia resistenza element lamp témoin lumineux résistance Heizkontrolleuchte luz testigo resistencia</p>	<p>DE elettrovalvola erogazione caffè coffee delivery electrovalve électrovanne distribution café Kaffeeausgabe-Elektroventil electroválvula erogación café</p>	<p>TE termostato thermostat thermostat Thermostat termostato</p>
<p>MS interruttore generale main switch interrupteur général Hauptschalter interruptor general</p>		<p>LE elettrovalvola autolivello level electrovalve électrovanne niveau automatique Füllstandselektroventil electroválvula de autocarga</p>	<p>EL resistenza element résistance Heizwiderstand resistencia</p>